

Panel mounting socket outlet, straight - flange 75x75, fixing centers 60x60



Product description	
BALS-Prd.-Nr	13704
EAN	4024941137041
Product category	Panel mounting socket outlet Quick-Connect, straight
Current	32A
Number of poles	3p
Poles	2P+PE
Position of earth contact	9 h
Voltage	380 up to 415V

Product description	
Frequency	50 and 60Hz
Protection degree	IP44
Colour code	red RAL 3000
Colour of appliance	Hinged lid red RAL 3000, Enclosure grey RAL 7035
Connection design	screwless spring terminals as cage clamp with Kontex-contact
Maximum conductor size	10,0 qmm
Cable entry	other
Height	90mm
Width	75mm
Depth	89mm
Flange size vertical	75mm
Flange size horizontal	75mm
Drill hole distance vertical	60mm
Drill hole distance horizontal	60mm
Material of enclosure	Polyamide
Contact	The contact carrier is made of polyamide, The contacts are brass

Logistics data	
Weight/pcs	0.166 kg / Piece
Packaging	Bag
Content amount	1 ST

Logistics data	
EAN	4024941137041
Length	89 mm
Width	75 mm
Height	90 mm
Weight	0.167 kg
Volume	600.75 ccm
Packaging	Carton
Content amount	10 ST
EAN	4024941826280
Length	128 mm
Width	225 mm
Height	399 mm
Weight	1.919 kg
Volume	11,491.2 ccm

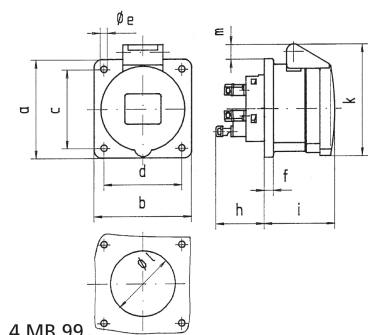

Ampere Polzahl	16 3	16 4	16 5	32 3	32 4	32 5
a	75,0	75,0	75,0	75,0	75,0	75,0
b	75,0	75,0	75,0	75,0	75,0	75,0
c	60,0	60,0	60,0	60,0	60,0	60,0
d	60,0	60,0	60,0	60,0	60,0	60,0
e ø	5,5	5,5	5,5	5,5	5,5	5,5
f	7,0	7,0	7,0	8,0	8,0	8,0
h	35,5	35,5	35,5	50,0	50,0	50,0
i	50,0	50,0	51,0	60,0	60,0	60,0
k	74,0	84,0	91,0	94,0	94,0	102,0
l ø	45,0	45,0	55,0	60,0	60,0	60,0
m	3,5	7,0	11,5	12,0	12,0	17,0
Leiter mm ² min	1,5	1,5	1,5	2,5	2,5	2,5
Leiter mm ² max	4	4	4	10	10	10